

To report a claim, call:

ADRIAN FLUX

0344 381 4420

FLUXDIRECT 

0344 381 4461

 **sterling**

0344 381 9350



Chartwell Insurance

0344 381 4463



0344 381 4462

Lines are open 24 hours a day, 7 days a week, all year round

UK call centre

Important

You must report all claims, whether or not they are your fault and whether you plan to make a claim or not.

You should call to report your claim as soon as possible and within 12 hours of the incident occurring.

Legal cover

Your policy includes free legal cover up to £100,000 and access to a legal advice helpline.

If you've had an accident that was not your fault, your legal cover could help you with;

- repairs for your vehicle
- arranging a hire car
- compensation for injury
and
- recovery of other losses, such as loss of earnings

Our claims handlers will discuss your legal cover with you. You can also find more information in the legal cover policy booklet, which is available on our website or through the link provided in your insurance documents.

Private Car Insurance Policy

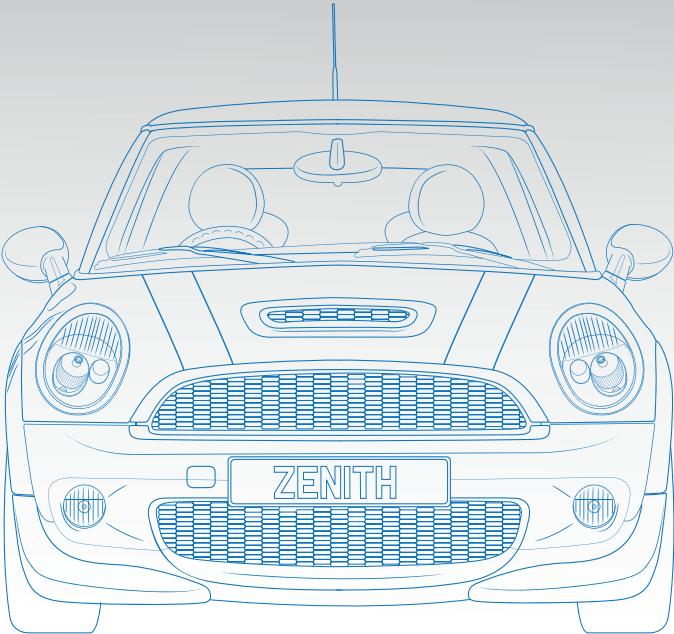

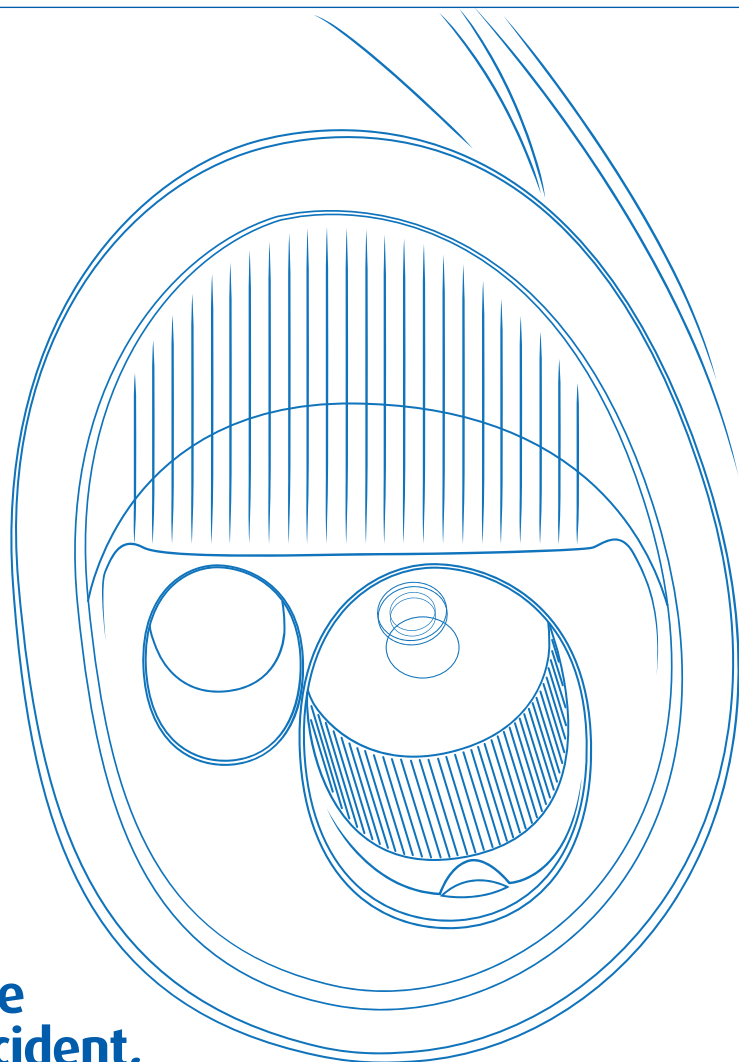

**If you have
had an accident,
call the 24 hour
Claims Helpline:
03330 436 519**

Please call within 24 hours of the accident, but ideally within 1 hour.
You may be entitled to a FREE courtesy car, FREE collection and delivery,
and we can provide a windscreen replacement service.

Contents

Important Customer Information	3
What to do in the Event of an Accident	4
Introduction to Your Policy	5
Definitions	6 - 7
Insurance Provided - Guide to Policy Cover	8 - 9
Section A - Loss of or Damage to the Insured Vehicle	10 - 12
Section B - Loss of or Damage to the Insured Vehicle by Fire or Theft	13 - 16
Exceptions to Sections A & B	17
Section C - Liability to Other People	18 - 19
Exceptions to Section C	20
Section D - Provision of a Courtesy Car	21
Section E - Personal Accident Benefits	22
Section F - Personal Belongings	23
Section G - Medical Expenses	23
Section H - Glass Damage	24
Section I - Replacement Locks	25
Section J - Foreign Use of the Insured Vehicle	26 - 27
Section K - No Claim Discount	28
Section L - Protected No Claim Discount	28
General Exceptions	29 - 30
General Conditions	31 - 34
Our Service Commitment	35 - 36
How we use your information	37 - 39
Notes	40 - 41
Numbers to Call	42

Important Customer Information

3

Pages 3 and 4 are for your guidance and do not form part of the insurance contract.

You should keep a complete record of all information (including copies of letters) supplied to us in taking out this insurance.

So that you understand what you are covered for, please read this policy, the Policy Schedule (which may make reference to endorsements) and the Certificate of Motor Insurance very carefully. You should pay special attention to the General Exceptions and General Conditions of this policy.

The words or phrases shown under the Definitions section of this policy document commencing on page 6 have the same meaning whenever they appear in this policy document or in the Certificate of Motor Insurance, policy schedule or endorsements.

So that you can easily identify these words and phrases they are shown in bold print throughout this policy document.

If you have any questions, or the cover does not meet your needs or any of the details are incorrect you should notify us immediately via your insurance intermediary.

Guidance notes

There are useful guidance notes shown in shaded boxes throughout the policy document. The guidance notes do not form part of the insurance contract but are there to help you understand it. You should always read the guidance notes in conjunction with the whole of the policy document.

What to do in the Event of an Accident

Regardless of blame it is important that you take the following action:

Stop: Stop as soon as possible, in a safe place (if you have a warning triangle, place it well before the obstruction). If anybody has been injured, call the police and ambulance service.

Sketch: Make a quick sketch of the direction and final position of each vehicle (it is worth keeping a pen and paper in **your** car).

Note down: **You** will need to make a note of:

- The vehicle registration number, name, address and telephone number of any other drivers involved in the accident.
- The number of passengers in each vehicle.
- The name and address of anyone who is injured (or suggesting they have been injured).
- The name, address and telephone number of any witnesses to the accident.
- The name, telephone number and constabulary of any police officer who attends the accident.

Take a photo: If you are able to do so, try and take photographs to support the positions of the vehicles and the extent of damage.

Provide: You must give your own details to anyone who has reasonable grounds for requesting them.

DO NOT: Do not admit responsibility, either verbally or in writing. Instead, simply supply your details along with your policy number to the other driver(s)/person(s) involved in the accident and ask him/her to call the claims advisors on 03330 436 558. By passing these details to the other person(s) involved in the accident you will give him/her the opportunity of obtaining assistance in progressing repairs and assisting with the provision of a courtesy vehicle if the circumstances of the accident warrant this.

If for any reason you have not been able to exchange details with other drivers or owners of property or you were in collision with an animal, you must report the accident to the police as soon as possible, and certainly within 24 hours of the accident.

Making contact following an incident.

**At the roadside?
Call 03330 436513**

To obtain immediate assistance at the roadside call the Roadside Priority Claims Helpline on 03330 436513.

Experienced advisors will take initial claim details and discuss recovery of your vehicle.

**Unable to call from the roadside?
Call 03330 436 519**

If you are unable to call from the roadside you must call the 24 hour Claims Helpline on 03330 436 519 as soon as it is safe to do so.

Please call within 24 hours of the accident, but **ideally within 1 hour**. This is regardless of whether **you** wish to make a claim under the policy or not. **Delay in notification of an incident may invalidate your right to claim.**

Please quote **your** policy number and give all relevant information about the incident. If **your** claim is due to theft, attempted theft or vandalism **you** must also inform the police and obtain a crime reference number.

Benefits of an immediate call

Calling straightaway provides you with benefits which may include the following (dependant on the level of policy cover you have):

- **FREE courtesy car** while your car is being repaired (subject to availability).
- Windscreen repair/replacement.
- **FREE** collection and re-delivery.
- **FREE** car cleaning service.
- Repairers' work guaranteed for three years.

Your claim and claims made against you, will be dealt with as quickly and fairly as possible. Please read the General Conditions in this policy booklet.

For our joint protection telephone calls may be recorded and monitored by us.

Introduction to Your Policy

Thank you for choosing to purchase a Zenith Insurance policy.

This Policy Document is evidence of a legally binding contract of insurance between you (the Insured) and us (Zenith Insurance Plc). This contract is entered into on the basis that:

- you have taken all reasonable care to answer all questions asked honestly, accurately and to the best of your knowledge; and
- any other information given either verbally or in writing by you, or on your behalf at the time you applied for insurance is also complete; and
- the information supplied has been given honestly and to the best of your knowledge and belief.

The information that you have given to us is shown on your signed proposal form or statement of fact or statement of insurance but will also include further information given either verbally or in writing by you or on your behalf at the time you applied for insurance.

You must read this policy document, the Policy Schedule and the Certificate of Motor Insurance together. The Policy Schedule tells you which sections of the policy apply. Please check all three documents carefully to make certain they give you the cover you want.

We have agreed to insure you against liability loss or damage that may occur within the geographical limits of the policy during any period of insurance for which you have paid, or agreed to pay the premium. The cover we provide is subject to the terms, conditions and exceptions contained in this policy document or in any endorsement applying to this policy document.

Nobody other than you (the Insured) and us (Zenith Insurance Plc) has any rights that they can enforce under this contract except for those rights that they have under road traffic law in any country in which this insurance applies.

Unless specifically agreed otherwise, this insurance shall be subject to English Law.

The terms and conditions of this policy and all other information concerning this insurance are communicated to you in the English language and we undertake to communicate in this language for the duration of the policy.



Gary Humphreys
Underwriting Director
Zenith Insurance Plc.

Authorised Insurers, registered in Gibraltar
No 84085. Registered Office: 846-848,
Europort, Gibraltar.

Zenith Insurance Plc is regulated by the Gibraltar Financial Services Commission and subject to a limited regulation by the Financial Conduct Authority and the Prudential Regulation Authority in respect of underwriting insurance business in the UK (No. 211787). Zenith Insurance Plc is a member of the Association of British Insurers.

The Financial Services Compensation Scheme covers this policy. You may be entitled to compensation from this scheme if we cannot meet our liabilities under this policy. Further information about compensation scheme arrangements is available at www.fscs.org.uk or by telephoning 0207 741 4100 or 0800 678 1100.

Definitions

The words or phrases shown below have the same meaning whenever they appear in this policy document or in the Certificate of Motor Insurance, Policy Schedule or Endorsements. So that you can easily identify these words and phrases they are shown in bold print throughout this policy document.

Approved Repairer

A motor vehicle repairer authorised by us or our representative to repair the insured vehicle following a valid claim under Section A or Section B of this insurance.

Certificate of Motor Insurance

A document, which is legal evidence of your insurance and is required by law and forms part of this contract of insurance. It shows the insured vehicle's registration number, who may drive it and what it may be used for. The Certificate of Motor Insurance must be read with this policy document.

Courtesy Car

A car loaned to you by our approved repairer whilst the insured vehicle is being repaired following a valid claim under Section A or Section B of this insurance.

Endorsements

A change in terms of this insurance, which replaces or alters the standard insurance wording.

Excess

An amount you have to pay towards the cost of a claim under this insurance. You have to pay this amount regardless of the circumstances leading to the claim.

Geographical Limits

The United Kingdom of Great Britain & Northern Ireland, the Isle of Man and the Channel Islands.

Insurance Intermediary

The intermediary who has placed this insurance with us, acting on your behalf as your agent and through whom all matters concerning this insurance are handled.

Insured Vehicle

The motor car, the details and registration number of which are shown in the Policy Schedule. Permanently fitted accessories (other than in-car entertainment, communication and navigation equipment) are included within this definition.

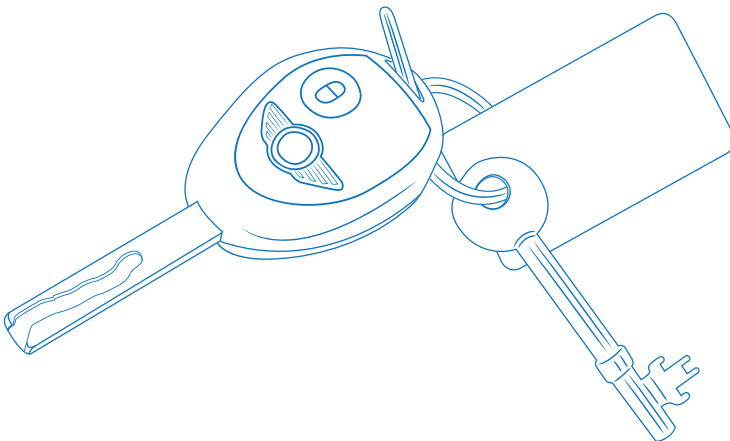

Definitions (continued)

In-car Entertainment, Communication and Navigation Equipment

Permanently fitted radios, cassette, MP3, compact disc or DVD players, telephones, CB radios and visual navigation equipment.

Portable items (such as radar detection equipment, personal digital assistants or portable GPS navigators), cassette tapes, memory cards, compact discs or DVDs are not included within this definition.

Market Value

The cost of replacing the insured vehicle at the time of loss or damage compared with one of the same make, model, specification and condition. If the insured vehicle was first registered as new in a country other than those contained within the geographical limits any assessment of market value will take into account that the car has been individually imported into a country contained within the geographical limits but will not include any delivery costs incurred at the time of importation. The market value will be assessed by an automotive engineer in conjunction with the published trade guides at the time of loss.

Panoramic roof

A vehicle roof system manufactured as single or multiple glass, or equivalent, panel(s) designed to cover the entire passenger compartment or the majority of it.

Period of Insurance

The period between the effective date and expiry date shown on the Policy Schedule and any subsequent period for which we accept renewal of the insurance.

Policy Schedule

The document which shows details of the insured policyholder and insurance protection provided and forms part of this contract of insurance.

Proposal Form

The application for insurance and declaration completed by you or on your behalf and signed by you. We have relied on the information provided on this form in entering into this contract of insurance.

Statement of Fact or Statement of Insurance

The form that shows the information that you gave us or that was given on your behalf at the time you applied for insurance. We have relied on the information provided on this form in entering into this contract of insurance.

Terrorism

Terrorism as defined in the Terrorism Act 2000.

Unattended

Where you or no person authorised by you are present in the insured vehicle, in charge of the insured vehicle or are not in a position to prevent unauthorised interference with the insured vehicle.

We/Us/Our

Zenith Insurance Plc.

Written down value

The value placed on your insured vehicle by the company who leased the vehicle to you under a lease agreement.

You/Your

The insured policyholder named in the Policy Schedule and Certificate of Motor Insurance.

Insurance Provided - Guide to Policy Cover

The level of cover provided by this insurance is shown on **your Policy Schedule**. The sections of this Private Car Insurance Policy that apply for each level of cover are as shown below. Cover is subject to any **endorsement** shown on your **Policy Schedule**.

Comprehensive

Sections A to K of this Private Car Insurance Policy apply.*

Third Party Fire and Theft

Sections B, C, J, and K of this Private Car Insurance Policy apply.*

Third Party Only

Sections C, J, and K of this Private Car Insurance Policy apply.*

The General Exceptions and General Conditions of this Private Car Insurance Policy apply to all levels of cover.

* Section L may also apply if shown on **your Policy Schedule**.

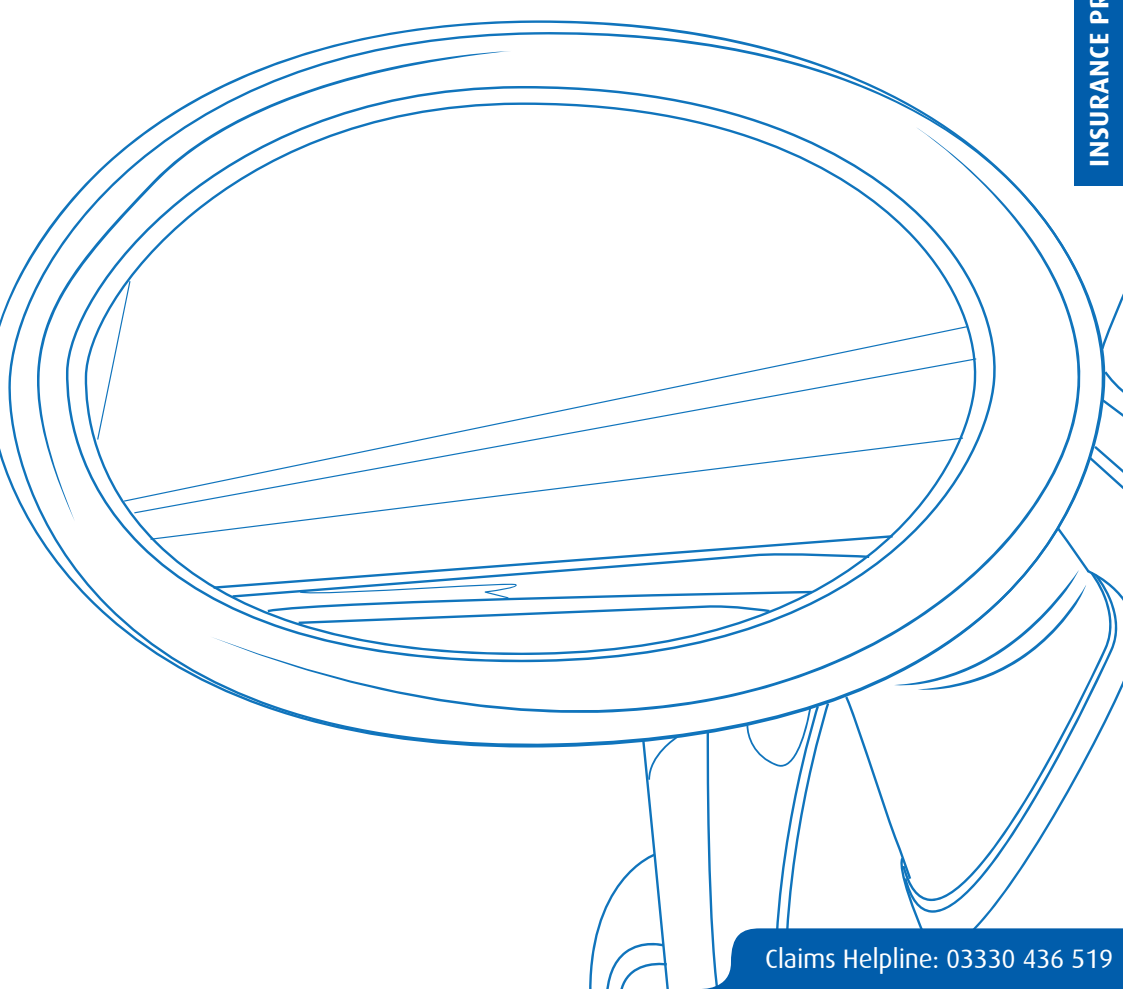

Insurance Provided - Guide to Policy Cover (continued)

Notification of changes

To keep **your** insurance up to date please notify **us** straight away via **your insurance intermediary** about changes which affect **your** cover.

Some examples are:

- A change of vehicle or **you** have purchased another vehicle to which **you** want **your** existing cover to apply.
- The **insured vehicle** is changed or modified from the manufacturer's standard specification or **you** intend to change or modify it (including the addition of optional fit accessories such as spoilers, skirts, alloy wheels etc).
- A change in the use of the **insured vehicle**.
- A change relating to the ownership of the **insured vehicle**.
- The **insured vehicle** has been stolen or is involved in an accident no matter how trivial.
- If the **insured vehicle** is likely to exceed the annual mileage declared at the commencement or renewal of the policy for which **you** may have received a premium discount.
- Any change in the main user of the **insured vehicle**.
- **You** wish a new driver to be covered.
- Someone who drives the **insured vehicle** is convicted of an offence (whether motor related or not) or fixed penalty or other licence endorsement or suffers from a medical condition or has a claim on another policy.
- Someone who drives the **insured vehicle** has any police enquiry or prosecution pending (note – if **you** have been stopped by the police a prosecution may be pending and must be disclosed).
- A change of occupation (full or part-time) by **you** or any other driver.
- A change of postal address.
- A change of garaging facilities and/or where the **insured vehicle** is normally kept overnight.

- The security system fitted to the **insured vehicle** is no longer in operation.

This is not a full list and if **you** are in any doubt **you** should advise **your insurance intermediary** for **your** own protection.

If the information provided by **you** is not complete or accurate:

- **we** may cancel **your** policy and refuse to pay any claim, or
- **we** may not pay any claim in full, or
- **we** may revise the premium and/or change the compulsory excess, or
- the extent of the cover may be affected.

Guidance notes - Notification of changes

The premium that you pay is based on information you supplied at the inception or renewal date of this insurance policy.

If your circumstances, or the circumstances of any driver covered by this policy change, then the premium needs to be recalculated to ensure we are collecting the correct premium for the risk.

It is important that you notify your insurance intermediary immediately of any changes such as those examples given under Notification of changes.

If you fail to supply details of changes or the information supplied by you is not complete or accurate then:

- **we** may cancel your policy and refuse to pay any claim, or
- **we** may not pay any claim in full, or
- **we** may revise the premium and/or change the compulsory excess, or
- the extent of the cover may be affected.

Section A - Loss of or Damage to the Insured Vehicle

This section only applies if the cover shown on **your Policy Schedule** is Comprehensive.

What is covered

We will cover **you** against loss or damage to the **insured vehicle** (less any **excess** that applies) caused accidentally or as a result of malicious damage or vandalism (malicious fire damage is covered by Section A of this policy). Loss or damage more specifically covered under Section B of this policy is excluded under this section of the policy.

Cover also applies under this section while the **insured vehicle** is in the custody of a member of the motor trade for servicing or repair.

Under this section we may either:

- pay for the damage to the insured vehicle to be repaired; or
- with **your** agreement provide a replacement car; or
- pay an amount of cash equivalent to the loss or damage.

The most we will pay will be either:

- the **market value** of the **insured vehicle** immediately before the loss; or
- the **market value** of a replacement car if **we** deal with **your** claim under the 'New Car Cover' sub section below, or
- the cost of repairing the **insured vehicle**, whichever is the lower amount; or
- the **written down value** or **market value**, whichever is lower, if **your insured vehicle** is under a lease agreement.

We are not liable for any amount you are contractually obliged to pay under any lease or finance agreement, you have entered into, over and above the cost of replacing your vehicle.

If the **insured vehicle** was not first registered from new in any country contained within the **geographical limits** we will not pay more than the purchase price paid by **you** at the time that **you** purchased the insured vehicle.

If the **insured vehicle** is deemed to be beyond economical repair or settlement is agreed under the 'New car cover' sub-section the

damaged car becomes **our** property once a claim is met under the policy. **You** must send us the vehicle registration document and MOT certificate if one is required by law before **we** are able to meet the claim.

If the **insured vehicle** is the subject of a Hire Purchase or Lease Agreement **we** will pay up to the amount defined under 'the most **we** will pay'.

This payment will be made to the Hire Purchase or Lease Company as owner of the insured vehicle, whose receipt of payment shall be a discharge of any claim under this section. If, under a Hire Purchase Agreement, you owe less than the proceeds of **your** claim, **we** will pay you the difference.

In-car entertainment, communication and navigation equipment

We will pay an amount of no greater than £300 after the deduction of any **excess** that applies in respect of any one occurrence for loss of or damage caused to permanently fitted **in-car entertainment, communication and navigation equipment**.

If this equipment forms part of the original vehicle specification and was fitted by the vehicle manufacturer or their authorised dealer at the time the **insured vehicle** was first registered from new, the amount of cover for any one occurrence will be increased to a maximum of £750 after the deduction of any **excess**.

Any amount payable in respect of **in-car entertainment, communication and navigation equipment** will not exceed the value of the equipment at the time of the loss or damage after making a reasonable deduction for wear and tear.

New car cover

If the **insured vehicle** is less than one year old (calculated from the date of first registration) at the time of the incident leading to a claim under this policy, and:

- suffers damage covered by the policy; and
- is beyond economical repair

Section A - Loss of or Damage to the Insured Vehicle (continued)

we will replace it with a new one of the same make, model and specification.

However, this new car cover only applies if:

- **you** have been the first and only registered keeper and owner of the insured vehicle; and
- a suitable replacement car is available in any country within the **geographical limits**; and
- anyone else who has an interest in the **insured vehicle** agrees; and
- the **insured vehicle** has covered less than 10,000 miles.

In the event that a vehicle of the same make, model and specification is unavailable **we** will settle the claim on the basis of the **market value** of the **insured vehicle** immediately before the loss.

Once a settlement has been agreed in accordance with this new car cover, the damaged car becomes **our** property.

If the **insured vehicle** is the subject of a Hire Purchase or Lease Agreement **we** will only agree settlement on the basis of this new car cover if we have the agreement of the Hire Purchase or Lease Company as owner of the **insured vehicle**.

Repairs

Repairs are normally undertaken by **our approved repairer**.

If you choose to use an alternative repairer:

- **we** will not guarantee the work after **you** have signed a customer satisfaction note and the **insured vehicle** has been returned to **you** by the repairer; and
- The most **we** will pay toward the cost of labour to repair the **insured vehicle** will be the labour rate quoted by **our approved repairer**. In these circumstances **we** may at **our** option settle the claim for repairs to the **insured vehicle** by making a cash payment based on the labour rate quoted by **our approved repairer** less the **excess** which applies to the claim.

If parts required for repairing the **insured vehicle** are not available in any country within the **geographical limits** our liability for those parts shall not exceed the manufacturers' last United Kingdom list price or if not listed the price of those parts for the nearest comparable car available in the United Kingdom.

We will not pay the cost of importing parts that are not available in any country within the **geographical limits**.

We may at **our** option use parts that have not been supplied by the original manufacturer to repair the **insured vehicle**. These parts will be subject to the **approved repairer's** guarantee.

We will not pay the cost of any repair or replacement which improves the **insured vehicle** to a better condition than it was in before the loss or damage. If this does happen **you** must make a contribution towards the cost of repair or replacement. **You** may be required to contribute to the cost of replaced items such as exhausts or tyres.

Guidance Notes – Finance or Lease agreement

If your insured vehicle is the subject of a finance or lease agreement and your vehicle is deemed to be damaged beyond economic repair due to a covered loss under the policy the market value or written down value placed on your insured vehicle may not be sufficient to satisfy that agreement.

This policy does not cover any amount you are contractually obliged to pay under any lease or finance agreement, you have entered into, over and above the cost of replacing your vehicle.

We would recommend that you discuss any concerns that you may have with your insurance intermediary who may be able to supply you with details of products available to cover any shortfall.

Young and Inexperienced Driver Excesses

You will be responsible for paying the following amounts while the **insured vehicle** is being driven by, is in the charge of or was last in the charge of the categories of driver listed below:

Age or experience of person driving, in charge of or last in charge of the insured vehicle	Amount of Excess
Aged 20 years and under	£300
Aged 21 to 24 years inclusive	£200
Aged 25 years and over but: <ul style="list-style-type: none"> • who holds a provisional driving licence; or • who holds an international driving licence; or • has held a full driving licence to drive a private motor car issued either in a country contained within the geographical limits or a member country of the European Union but for less than one year. 	£150

The Young and Inexperienced Driver **Excess** applicable at the time of loss or damage is determined by the age or driving experience of the person driving/in charge of the **insured vehicle** at the inception date or last renewal date of the policy whichever is the later.

The amounts shown above are in addition to any other **excesses** shown elsewhere in this policy document or on **your Policy Schedule** or in any **endorsement**.

Protection and Recovery

If the **insured vehicle** cannot be driven following an incident leading to a valid claim under this section, **we** will pay:

- the cost of its protection and removal to the nearest **approved repairer**, competent repairer or nearest place of safety; and

- the cost of re-delivery after repairs to **your** home address; and
- the cost of storage of the **insured vehicle** incurred with **our** written consent.

If the **insured vehicle** is damaged beyond economical repair **we** will arrange for it to be stored safely at premises of **our** choosing.

You should remove **your** personal belongings from the **insured vehicle** before it is collected from **you**.

In the event of a claim being made under the policy **we** have the right to remove the **insured vehicle** to an alternative repairer, place of safety or make **our** own arrangements for re-delivery at any time in order to keep the cost of the claim to a minimum.

Guidance Notes – Flood Advice

- If possible move your car to a safer place out of the reach of floodwater before the flood strikes (e.g. to higher ground).
- Do not attempt to drive your car through floodwater as it is inevitable that this will damage your engine particularly if your car has a diesel engine or turbo charger. The policy does not pay for electrical faults and these are also likely to occur if you do drive through floodwater.
- If your car is submerged do not try to start the engine. If possible get your car pushed or towed out of the water and allow it to dry out. You may be lucky and the water may not have penetrated sufficiently to ruin the engine.
- Repairs to the **insured vehicle** resulting from flood damage are covered if your policy cover is comprehensive but claims will be subject to the policy excesses. A comprehensive policy will also pay for towing as well as damage to upholstery, carpets and stereo systems resulting from flooding but only up to the limits shown within this document.

Section B - Loss of or Damage to the Insured Vehicle by Fire or Theft

This section only applies if the cover shown on **your Policy Schedule** is either Comprehensive or Third Party Fire and Theft.

What is covered

We will cover **you** against loss of or damage to the **insured vehicle** (less any **excess** that applies) caused by fire (other than fire by vandalism or malicious intent), lightning, explosion, theft or attempted theft.

Cover also applies under this section while the **insured vehicle** is in the custody of a member of the motor trade for servicing or repair.

Under this section we may either:

- pay for the damage to the insured vehicle to be repaired; or
- with **your** agreement provide a replacement car; or
- pay an amount of cash equivalent to the loss or damage.

The most we will pay will be either:

- the **market value** of the **insured vehicle** immediately before the loss; or
- the **market value** of a replacement car if **we** deal with **your** claim under the 'New Car Cover' sub section, or
- the cost of repairing the **insured vehicle**, whichever is the lower amount; or
- the **written down value** or **market value**, whichever is lower, if **your insured vehicle** is under a lease agreement.

We are not liable for any amount **you** are contractually obliged to pay under any lease or finance agreement, **you** have entered into, over and above the cost of replacing **your** vehicle.

If the **insured vehicle** was not first registered from new in any country within the **geographical limits** **we** will not pay more than the purchase price paid by **you** at the time that **you** purchased the **insured vehicle**.

If the **insured vehicle**:

- is stolen and has not been recovered at the time of settlement; or
- is deemed to be beyond economical repair, as a result of loss covered under this section of the policy

the lost or damaged vehicle becomes our property once a claim is met under the policy. **You** must send **us** the vehicle registration document and MOT certificate (if one is required by law) before **we** are able to meet the claim.

If the **insured vehicle** is the subject of a Hire Purchase or Lease Agreement **we** will pay up to the amount defined above under 'the most **we** will pay'. This payment will be made to the Hire Purchase or Lease Company as owner, whose receipt shall be a discharge of any claim under this section. If, under a Hire Purchase Agreement, **you** owe less than the proceeds of **your** claim, **we** will pay **you** the difference.

In-car entertainment, communication and navigation equipment

We will cover you for loss of or damage caused to permanently fitted **in-car entertainment, communication or navigation equipment** caused by fire (other than fire by vandalism or malicious intent), lightning, self ignition, explosion, theft or attempted theft. The most **we** will pay is in accordance with the cover provided by **your** policy and is detailed below:

- Equipment forming part of the original vehicle specification and fitted by the vehicle manufacturer or their authorised dealer at the time the **insured vehicle** was first registered from new:

Cover applying to your policy	Limits Applying
Comprehensive	Up to £750 any one occurrence after the deduction of any excess
Third Party Fire & Theft	Up to £300 any one occurrence after the deduction of any excess

- Equipment not forming part of the original vehicle specification:

Cover applying to your policy	Limits Applying
Comprehensive	Up to £300 any one occurrence after the deduction of any excess
Third Party Fire & Theft	Up to £300 any one occurrence after the deduction of any excess

Any amount payable in respect of **in-car entertainment, communication and navigation equipment** will not exceed the value of the equipment at the time of the loss or damage after making a deduction for wear and tear.

New car cover

If the **insured vehicle** is less than one year old (calculated from the date of first registration) at the time of the incident leading to a claim under this policy, and:

- is stolen and not recovered; or
- is beyond economical repair, as a result of a loss covered under this section of the policy.

we will replace it with a new one of the same make, model and specification.

However, this new car cover only applies if:

- **you** have been the first and only registered keeper and owner of the **insured vehicle**; and
- a suitable replacement car is available in a country contained within the **geographical limits**; and
- anyone else who has an interest in the **insured vehicle** agrees; and
- the **insured vehicle** has covered less than 10,000 miles.

In the event that a vehicle of the same make, model and specification is unavailable **we** will settle the claim on the basis of the market value of the **insured vehicle** immediately before the loss.

Once a settlement has been agreed in accordance with this new car cover, the lost or damaged car becomes **our** property.

If the **insured vehicle** is the subject of a Hire Purchase or Lease Agreement **we** will only agree settlement on the basis of this new car cover if **we** have the agreement of the Hire Purchase or Lease Company as owner of the **insured vehicle**.

Repairs

Repairs are normally undertaken by **our approved repairer**.

If **you** choose to use an alternative repairer:

- **we** will not guarantee the work after **you** have signed a customer satisfaction note and the **insured vehicle** has been returned to **you** by the repairer; and
- the most **we** will pay toward the cost of labour to repair the **insured vehicle** will be the labour rate quoted by **our approved repairer**. In these circumstances **we** may at our option settle the claim for repairs to the **insured vehicle** by making a cash payment based on the labour rate quoted by our **approved repairer** less the **excess** which applies to the claim.

If parts required for repairing the **insured vehicle** are not available in any country contained within the **geographical limits** **our** liability for those parts shall not exceed the manufacturers' last United Kingdom list price or if not listed the price of those parts for the nearest comparable car available in any country contained within the **geographical limits**. **We** will not pay the cost of importing parts that are not available in any country contained within the **geographical limits**.

We may at **our** option use parts that have not been supplied by the original manufacturer to repair the **insured vehicle**. These parts will be subject to the **approved repairer's** guarantee.

Section B - Loss of or Damage to the Insured Vehicle by Fire or Theft (continued)

We will not pay the cost of any repair or replacement which improves the **insured vehicle** to a better condition than it was in before the loss or damage. If this does happen **you** must make a contribution towards the cost of repair or replacement. **You** may be required to contribute to the cost of replaced items such as exhausts or tyres.

Young and Inexperienced Driver Excesses

You will be responsible for paying the following amounts in respect of any claim relating to loss of or damage caused by fire (other than by vandalism or malicious intent), lightning, self ignition, explosion, theft or attempted theft while the **insured vehicle** is being driven by or is in the charge or was last in the charge of the categories of driver listed:

Age or experience of person driving, in charge of or last in charge of the insured vehicle	Amount of Excess
Aged 20 years and under	£300
Aged 21 to 24 years inclusive	£200
Aged 25 years and over but: <ul style="list-style-type: none"> • who holds a provisional driving licence; or • who holds an international driving licence; or • has held a full driving licence to drive a private motor car issued either in a country contained within the geographical limits or a member country of the European Union but for less than one year. 	£150

The Young and Inexperienced Driver **Excess** applicable at the time of loss or damage is determined by the age or driving experience of the person driving/in charge of the **insured vehicle** at the inception date or last renewal date of the policy whichever is the later.

The amounts shown above are in addition to any other **excesses** shown elsewhere in this policy document or on **your Policy Schedule** or in any **endorsement**.

Protection and Recovery

If the **insured vehicle** cannot be driven following an incident leading to a valid claim under this section, **we** will pay:

- the cost of its protection and removal to the nearest **approved repairer**, competent repairer or nearest place of safety; and
- the cost of re-delivery after repairs to **your** home address; and
- the cost of storage of the **insured vehicle** incurred with **our** written consent.

If the **insured vehicle** is damaged beyond economical repair **we** will arrange for it to be stored safely at premises of **our** choosing.

You should remove your personal belongings from the **insured vehicle** before it is collected from **you**.

In the event of a claim being made under the policy, **we** have the right to remove the **insured vehicle** to an alternative repairer, place of safety or make **our** own arrangements for re-delivery at any time in order to keep the cost of the claim to a minimum.

Guidance Notes - Preventing Crime

- Don't give criminals an easy ride. Car crime makes up 20% of all recorded crimes in the UK.
- Most thefts can be prevented - and it's in your interest and ours to take some simple precautions. Most things are common sense.
- Lock your car and remove your ignition key/locking device when leaving it for even a short time e.g. at a petrol station or cashpoint machine.
- Vehicle thieves often steal the keys first especially if the vehicle has an immobiliser and break into houses just to access keys to steal the car. Always keep keys secure even inside your home (do not leave keys where a burglar can easily find them).
- Keys and locking devices should always be kept in a safe and secure place - do not leave them on a wall hook, windowsill or in a jacket pocket close to the vehicle.
- Take appropriate measures to safeguard the vehicle when showing it to prospective purchasers.
- Do not keep items such as the car registration document, service book, MOT certificate or certificate of insurance in the car and never leave any valuables on view in the car. You should remove items such as CD players, Radios/MP3 players and portable satellite navigation equipment whenever possible.
- Use good-quality locks and security devices.
- Park in a secure place if you can. If you have a garage, use it and lock it.

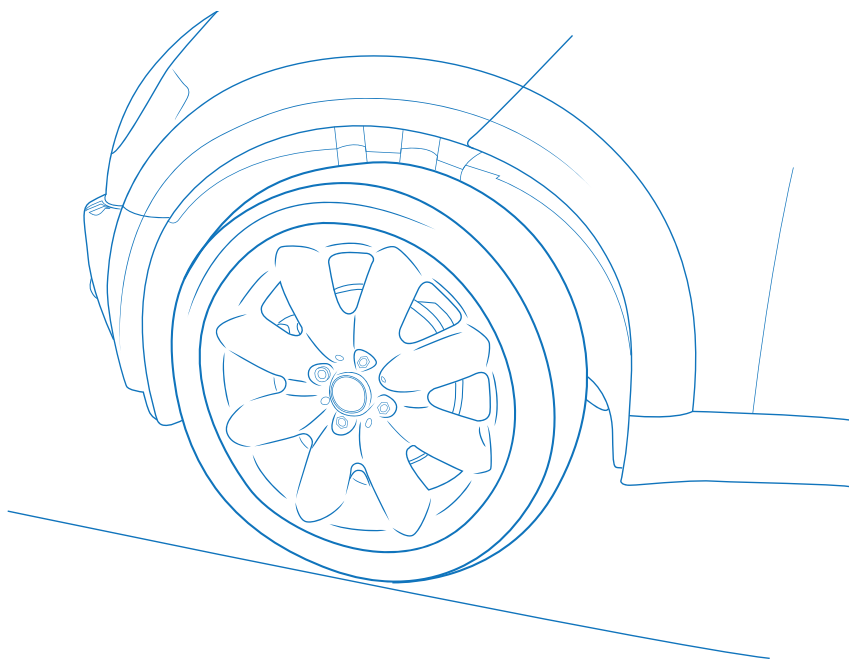

Exceptions to Sections A & B

What is not covered

These sections of **your** insurance policy do not cover the following:

- The amount of any **excess** shown in the **Policy Schedule** or in this policy document or in any **endorsement** that applies.
- Indirect losses which result from the incident that caused **you** to claim, for example, **we** will not pay compensation for **you** not being able to use the **insured vehicle**.
- Wear and tear, mechanical or electrical breakdown including failure of any equipment, integrated circuit, computer chip, computer software or computer related equipment and failure or breakages of any part due to application of brakes or road shocks.
- Depreciation or loss of value following repairs.
- Loss of or damage to the **insured vehicle** arising from the vehicle being taken by a person:
 1. who is not permitted to drive under the **Certificate of Motor Insurance** or is excluded by **endorsement**; and
 2. who is also **your** employee or a member of **your** family or household or in a close personal relationship with **you** or a member of **your** family or household.
- Loss suffered due to any person obtaining any property by fraud or deception, for example a purchaser's cheque not being honoured by their bank.
- Loss or damage to the **insured vehicle** where possession of it is gained by deception on the part of someone pretending to be a buyer or someone pretending to act on behalf of a buyer.
- Loss or damage to the **insured vehicle** as a result of:
 1. lawful repossession
 2. return to its rightful owner
 3. seizure by the police or their authorised representatives.
- Loss or damage caused by pressure waves from aircraft or any flying object.
- Loss of or damage to keys, lock or ignition activators, alarm or immobiliser activators (except as insured under Section I of this insurance - Replacement Locks).
- Repairs, re-programming or replacement of any component, including locks on the **insured vehicle**, resulting from the loss of or damage to the insured vehicle keys, lock or ignition activators or alarm or immobiliser activators (except as insured under Section I of this insurance - Replacement Locks).
- Loss of or damage to the **insured vehicle** and/or **in-car entertainment, communication and navigation equipment** while the insured vehicle is left **unattended** arising from theft or attempted theft when:
 1. ignition keys have been left in or on the **insured vehicle**; or
 2. the **insured vehicle** has not been secured by means of door and boot lock; or
 3. any window or any form of sliding or removable roof or hood have been left open or unlocked; or
 4. the **insured vehicle** is fitted with a manufacturer's standard security device and the device is not operational or is not in use.
- Loss or damage caused by an inappropriate type or grade of fuel being used.
- Confiscation, requisition or destruction by or under the order of any Government or Public or Local Authority.
- Damage to tyres caused by braking, punctures, cuts or bursts.
- Damage caused by frost unless **you** took precautions to protect the **insured vehicle**.
- Fire damage resulting from malicious acts or vandalism if the cover shown on **your** policy schedule is TPFT.
- Loss or damage caused deliberately by **you** or by any person who is in charge of the **insured vehicle** with **your** permission.
- any amount **you** are contractually obliged to pay under any lease or finance agreement, **you** have entered into, over and above the cost of replacing the **insured vehicle**.

Section C - Liability to Other People

What is covered

Use of the insured vehicle

We will cover the categories of people listed below for their legal liability for death, bodily injury or damage to property arising out of the use of the **insured vehicle** including the towing of any single trailer, trailer-caravan or broken down vehicle while it is attached to the **insured vehicle** provided he/she follows all applicable laws and regulations for the towing of vehicles and it is not being towed for hire or reward

- **You**; and
- any person permitted to drive the **insured vehicle** under the **Certificate of Motor Insurance** who is driving with **your** permission; and
- any passenger in the **insured vehicle**; and
- any person using (but not driving) the **insured vehicle** for social domestic and pleasure purposes with **your** permission; and
- the employer or business partner of any person named as a permitted driver on **your Certificate of Motor Insurance** in the event of an accident occurring while the **insured vehicle** is being used for business by that named person as long as **your Certificate of Motor Insurance** allows business use by such person; and
- the legal representatives of any person who would have been covered under this section.

Third Party Property Damage Limit

The most **we** will pay for property damage for any one claim, or series of claims arising out of any one event is £20,000,000. The most **we** will pay in costs for any one property damage claim or series of property damage claims arising out of any one event is £5,000,000.

Legal Costs

If there is an accident that is covered under this insurance **we** may at **our** absolute discretion consider payment in respect of the following legal costs:

- solicitors fees for representing **you** at any

fatal accident enquiry, Coroner's, Magistrates or similar court; and

- the cost of legal services to defend **you** against a charge of manslaughter or causing death by dangerous or reckless driving.

If **we** agree to pay these costs under this policy the choice and appointment of legal representation and the extent of any assistance that we provide will be entirely at our discretion. There will be no agreement to pay these costs unless we have confirmed this to **you** in writing.

Driving Other Cars

If it is stated on **your Certificate of Motor Insurance** that **you** may drive any private car which is not owned by **you** or hired to **you** under a rental, hire purchase or lease agreement then **we** will provide cover, under this section of the policy only, whilst **you** are driving that car.

This extension applies to the policyholder only. Cover does not apply in respect of any other driver named under this policy.

Additionally, Driving Other Cars cover will not apply if:

- **you** do not have the car owners permission to drive the car; or
- this policy is issued in the name of a company or firm; or
- the **insured vehicle** is sold, disposed of, declared a total loss or is stolen and not recovered; or
- the car **you** are driving is owned by or provided by an employer or business partner; or
- **you** drive the car outside of the geographical limits of this policy; or
- the car does not have valid cover in force under another insurance policy; or
- the car is not registered within the **geographical limits** of the policy; or
- the car **you** want to drive has been seized or confiscated by or on behalf of, any government or public authority; or
- the car is over 3,500 kg Maximum

Section C - Liability to Other People (continued)

- Authorised Mass (MAM); or
- the car is being used in respect of **your** business or profession; or
- the car is fitted with more than 7 seats in total.

Guidance Notes – Driving Other Cars

The driving other cars benefit is supplied by us (if shown on your certificate of motor insurance) to allow you to drive a car owned by somebody else, with their permission, on a temporary one off basis due to necessity and not to cover you to drive another car regularly. If that is your intention then ask the car owner to get you added onto their insurance policy.

You must bear in mind that you are only covered for Third Party Only benefits under this section of the policy which means that if the car is damaged or stolen we will not pay the cost to repair or replace it. Also, there is no cover under this section of the policy for anyone else you have named to drive under this policy including your spouse, nor if you take the car abroad or want to use it in connection with your business or profession.

The car you want to drive must be registered, and already have insurance that is valid, within the geographical limits of the policy. We define a private car, under this section of the policy, as a Category M1 vehicle as shown on the V5c Registration Certificate but with no more than 7 seats in total and with a Maximum Authorised Mass (MAM) of no more than 3,500 kg. This is the same maximum MAM as you are allowed to drive under category B of your driving licence as issued by the DVLA or DVANI.

Driving Other Cars cover does not allow you to secure the release of a private car, other than the vehicle identified on the certificate of motor insurance by its registration mark, which has been seized by, or on behalf of, any government or public authority.

If you are in doubt as to whether you qualify for the Driving Other Cars benefit or that you have entitlement to drive a specific vehicle or under specific circumstances then please consult your insurance intermediary prior to driving the car otherwise you run the risk of driving uninsured.

Emergency Medical Treatment

We will pay emergency treatment charges required by the Road Traffic Acts. If this is the only payment **we** make, it will not affect **your** No Claim Discount.

Exceptions to Section C

What is not covered

We shall not be liable:

- if the person claiming is otherwise insured; or
- for loss or damage to property belonging to or in the care of any person insured under this section or for not being able to use any such property; or
- for damage to the **insured vehicle** or property in it or being conveyed in it or for not being able to use any such property; or
- for loss or damage to any trailer or caravan being towed by the **insured vehicle** or for any property carried in or on that trailer or caravan or for not being able to use any such trailer or caravan; or
- if the death of or bodily injury to any person covered under this section arises out of or in the course of his/her employment except where such liability must be covered under the Road Traffic Acts; or
- for death or bodily injury to any person being carried in or on any trailer or caravan; or
- if a person who was not driving makes a claim and he/she knew that the person driving did not hold a valid driving licence; or
- for any loss, damage, death or injury arising as a result of a 'road rage' incident or caused deliberately by **you** or any other person claiming under this policy.

Section D - Provision of a Courtesy Car

This section applies only if the cover shown on **your Policy Schedule** is Comprehensive.

What is covered

If a valid claim is made under this policy, and the **insured vehicle** is to be repaired by one of **our approved repairers**, we will provide **you** with a **courtesy car** (subject to availability) for the duration of the repairs.

If the parts required to repair the **insured vehicle** are not immediately available to **our approved repairer** we reserve the right to withhold the provision of a **courtesy car** until such time as the necessary parts are available and repair work can proceed.

If the **insured vehicle** is accepted by **our approved repairer** as being a repairable proposition, but it is subsequently deemed by **us** to be beyond economical repair, **we** reserve the right to withdraw the courtesy car immediately.

The courtesy car can only be provided subject to availability and will be supplied subject to our **approved repairer's** standard terms and conditions, for use in any country contained within the **geographical limits** only. **Our** aim is to keep **you** mobile rather than the **courtesy car** being a replacement for the **insured vehicle** in terms of status or performance. The **courtesy car** will normally be a small hatchback of less than 1200cc.

While **you** are in possession of the **courtesy car**, cover for loss of or damage to the car will be provided by this policy in accordance with its terms, **endorsements** and conditions, including **excesses** for which **you** will be responsible. We will not make a charge for this cover.

Any accidents or losses while **you** are in possession of the **courtesy car** must be reported to **us** immediately, and may affect **your** No Claim Discount.

Driving of the courtesy car will be limited solely to those persons named on **your Certificate of Motor Insurance**, and the use of the car will be restricted to the use described on that certificate.

You are not required to inform **us** when **you** are supplied with a **courtesy car** from our **approved repairer**.

You must return the **courtesy car** to **our approved repairer** either when **we** ask **you** to do so or if this insurance falls due for renewal and **you** fail to renew it with **us**.

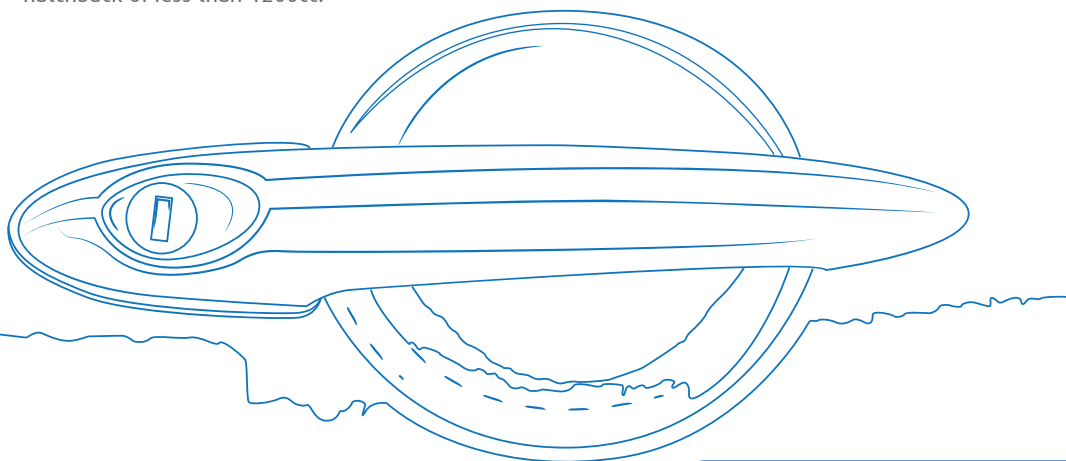

Section E - Personal Accident Benefits

This section applies only if the cover shown on **your Policy Schedule** is Comprehensive.

What is covered

We will pay the following amounts for each person if **you, your** legally married spouse or civil partner accidentally receives an injury as detailed below. Payment will only be made if the injury, independently of any other cause, and within 3 months of the accident results in:

Death	£5,000
Complete and permanent loss of sight of one or both eyes	£2,000
Complete and permanent loss of one or more limbs	£2,000

Payment will only be made where the injury or death directly results from an accident while getting into, out of or travelling in the **insured vehicle** (or any other private motor car which you do not own).

We will make payment to **you** or **your** legal representatives. Payment made under this section will be limited to a maximum amount of £5,000 in any one year of insurance regardless of the number of persons injured or the types of injury sustained.

What is not covered

This personal accident benefit does not apply:

- to policies issued in the name of a company or firm; or
- where death or bodily injury is caused by suicide or attempted suicide, natural disease or pre-existing physical defect; or
- in respect of death or or bodily injury to the driver at the time of the accident if such person was convicted for driving under the influence of drugs or alcohol at the time of the accident; or
- for death or bodily injury to any person in the **insured vehicle** if such person had not complied with the law relating to the use of seat belts.

Section F - Personal Belongings

This section applies only if the cover shown on **your Policy Schedule** is Comprehensive.

What is covered

We will pay a total amount no greater than £100 for personal belongings while in the **insured vehicle**, if they are lost or damaged because of any accident, fire, theft or attempted theft or by malicious means.

What is not covered

Personal belongings cover does not apply:

- to policies issued in the name of a company or firm; or
- to money, stamps, lottery tickets, vouchers, credit, debit or payment cards, tickets or securities; or
- to jewellery or furs; or
- to radar detection equipment; or
- to goods or samples, tools or equipment connected with any trade or business; or
- in respect of theft of property from the unattended **insured vehicle** if:
 1. ignition keys have been left in or on the insured vehicle; or
 2. the **insured vehicle** has not been secured by means of door and boot lock; or
 3. any window or any form of sliding or removable roof or hood have been left open or unlocked; or
 4. the **insured vehicle** is fitted with a manufacturer's standard security device and the device is not operational or is not in use.
- in respect of theft of property from an open-topped or convertible car unless the property was being kept in a locked boot or locked glove compartment; or
- in respect of any permanently fitted audio, navigation or telephone equipment (except as insured under Section A or Section B of this insurance).

Section G - Medical Expenses

This section applies only if the cover shown on **your Policy Schedule** is Comprehensive.

What is covered

We will pay up to £200 per person for medical expenses for anyone who is injured while they are in the **insured vehicle**.

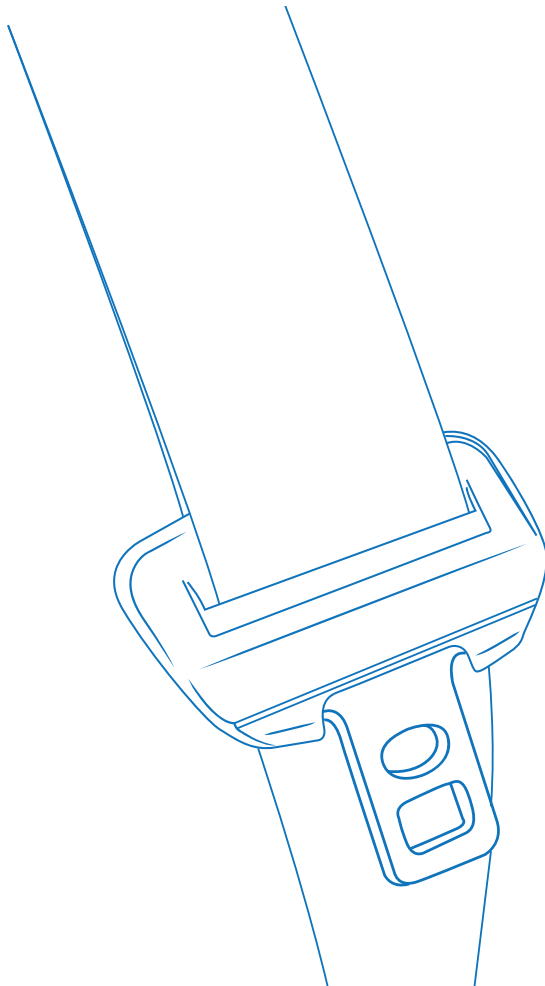

Section H - Glass Damage

This section applies only if the cover shown on **your Policy Schedule** is Comprehensive.

What is covered

We will pay the cost of repair/replacement of broken glass windscreens or glass windows, without loss of No Claim Discount providing the work is carried out by **our** approved replacement service.

We may at **our** option use parts that have not been supplied by the original manufacturer. If **you** insist that **we** use parts supplied by the original manufacturer even though alternative non-original manufacturer parts are available **you** will be required to pay us any difference in the cost of such parts.

If an incident occurs involving the breakage of multiple items of glass **we** will only pay for one piece of glass under this extra benefit.

In the event of an incident likely to give rise to a claim for damaged glass please call the **24 hour Claims Helpline on 03330 436 519**.

If **you** do not use **our** approved replacement service cover is limited to an amount of £75 (after the deduction of any **excess** that applies) in any one annual **period of insurance**, without loss of No Claim Discount.

What is not covered

- **You** will be required to pay the first £100 of each claim under this section in respect of a replacement windscreen or window. Where the windscreen or window can be repaired and does not require replacement, any claim for repair will not be subject to payment of an **excess**.
- **We** will not pay claims for mechanical items associated with the window mechanisms of the **insured vehicle** under this section.
- **We** will not pay the cost of importing parts or items of replacement glass that are not available in any country contained within the **geographical limits**
- **We** will not pay claims for the repair or replacement of sunroofs, glass roofs, panoramic windscreens, lights/reflectors or folding rear windscreen assemblies under this section.
- Loss or damage caused deliberately by you, or any person who is in charge of the insured vehicle with **your** permission.

Section I - Replacement Locks

25

SECTION I

This section applies only if the cover shown on **your Policy Schedule** is Comprehensive.

What is covered

In the event that:

- one or more of the keys or lock transmitters or entry cards for a keyless entry system for the **insured vehicle** is stolen; and
- it can be established that the identity or garaging address of the **insured vehicle** is known to any person who may have **your** keys or transmitter or entry card, then

we will pay an amount of no greater than £300 for any one occurrence (after the deduction of the **excess** that applies to this section) towards the cost of replacing:

- the door locks and/or boot or tailgate lock; and
- the ignition/steering lock; and
- the lock transmitter and/or central locking system.

What is not covered

We will not pay:

- any claim resulting from the keys, lock transmitters or entry cards being left in or on the **insured vehicle**; when **unattended**, or
- the first £150 of each claim under this section; or
- the cost of replacing alarms or other security devices used in connection with the **insured vehicle** under this section of the policy.

Section J - Foreign Use of the Insured Vehicle

What is covered

Legal minimum insurance

While the **insured vehicle** is in:

- any country which is a member of the European Union (EU); or
- Any country which the Commission of the European Communities is satisfied has made arrangements of Article (8) of EC Directive 2009/103/EC relating to civil liabilities arising from the use of a motor vehicle.

this policy provides the minimum level of cover in respect of liability which is legally insurable in the country concerned. This legal minimum insurance does not include cover for loss of or damage to the **insured vehicle**.

Full policy cover

In addition to the legal minimum cover shown above, this policy is automatically extended to provide the cover shown in **your Policy Schedule** to any member country of the EU and also Andorra, the Channel Islands, Gibraltar, Iceland, Liechtenstein, Monaco, Norway, San Marino and Switzerland provided that:

- **you** notify **your insurance intermediary** before **your** journey abroad; and
- the use of the **insured vehicle** abroad is limited to no more than 30 days in total in any one annual **period of insurance**; and
- **you** or any permitted driver are normally resident within the **geographical limits** of this policy; and
- **your** visit abroad is for social, domestic or pleasure purposes.

A Green Card is not required for the countries listed above and no additional premium will be payable as long as the qualifying conditions are met. Driving Other Cars cover does not apply while the **insured vehicle** is being used abroad.

If the policy is extended to provide the cover shown on **your Policy Schedule** whilst abroad:

- insurance is automatically provided on the **insured vehicle** while it is being transported (including loading and unloading) between ports in countries where **you** have cover, provided the **insured vehicle** is being transported by rail or a recognised sea route of not more than 65 hours duration; and
- **we** will pay the cost of delivery of the **insured vehicle** to **you** after repairs in the country in which damage was sustained, or to **your** home address if the damage cannot be repaired economically by the intended time of **your** return to any country contained within the **geographical limits** or if the car is stolen and recovered after **your** return to any country contained within the **geographical limits**; and
- **we** will pay the amount of foreign customs duty for which **you** are liable as a direct result of loss or damage to the **insured vehicle** preventing its return to any country contained within the **geographical limits**.

If **you** wish to extend full policy cover outside of the countries, scope and period limitations shown above **you** must contact **your** insurance intermediary to obtain **our** agreement to provide cover in advance of **your** intended trip abroad.

Any agreement by **us** to extend full policy cover beyond the limits above may be subject to an additional premium and policy restrictions.

The exceptions applying to sections A, B & C of this insurance also apply to this section.

Section J - Foreign Use of the Insured Vehicle (continued)

Guidance Notes - Going Abroad

The policy does not automatically provide full cover abroad so, before travelling, please contact your insurance intermediary to arrange cover. The extended full insurance will then cover you in the countries for which we have agreed to provide cover and when your vehicle is travelling by rail or sea between those countries.

Unless you notify your insurance intermediary in advance of a trip abroad, the cover may be limited to the minimum cover you need under the law of the relevant country (EU minimum insurance). This minimum insurance will not provide any cover for damage to or theft of your insured vehicle.

Take your certificate as evidence of insurance when you travel abroad.

Important: Driving Other Cars cover does not apply abroad.

If your insured vehicle suffers any loss or damage that is covered by this insurance and the insured vehicle is in a country where you have cover, we will refund any customs duty you pay to temporarily import your insured vehicle.

Although full policy cover abroad is automatically available for up to 30 days in any one annual period of insurance we may, on request, agree to extend cover up to a maximum of 90 days. A charge may apply. Please contact your intermediary for further information.

We will only consider extending this insurance to countries which are covered by the International Green Card system.

If you are involved in any accident or incident whilst abroad please call the 24 hour Claims Helpline using the international dialling code for the UK: 0044 3330 436 519.

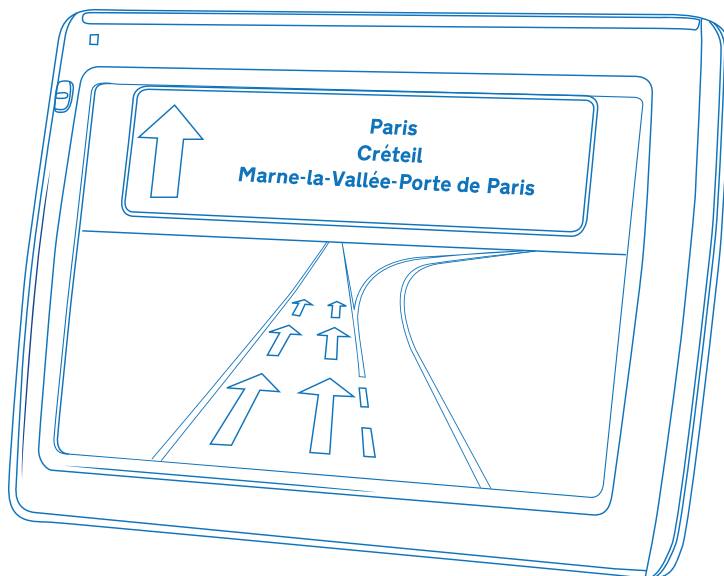

Section K - No Claim Discount

As long as no claim is made under this policy during any annual **period of insurance**, we will give you a discount when **you** renew **your** insurance. The discount **you** will receive will be in accordance with **our** No Claim Discount scale applicable at the time **your** policy is due for renewal. However, **your** entitlement will be affected in the event of a claim or multiple claims being made under this policy.

Your No Claim Discount will not be affected in the following circumstances:

- if **we** make a full recovery of all payments made by **us** in connection with the claim; or
- if **you** only claim for a broken windscreen or window under Section H of this policy and use **our** approved replacement service; or
- if **we** only have to pay for an emergency treatment fee.

If **you** make a claim or if a claim is made against **you** for an event which **you** may not consider to be **your** fault and **we** have to make a payment this will affect **your** No Claim Discount unless we can recover **our** outlay in full from the responsible party.

If **you** decide to cancel **your** policy and premiums remain outstanding **we** will not be able to issue proof of No Claim Discount until the outstanding premiums are paid.

You cannot transfer **your** No Claim Discount to somebody else.

Guidance Notes – No Claim Discount

There may on occasions be incidents (possibly involving a cyclist or pedestrian) where, although you are not claiming for damage to your vehicle, there is a potential for a claim against your policy by the third party.

In these circumstances we may disallow your No Claim Discount for up to twelve months until we are confident that a third party claim is unlikely to materialise.

Section L - Protected No Claim Discount

This section only applies if shown on **your** **Policy Schedule**.

You must have proved that you have an entitlement to at least four years' No Claim Discount.

You will not lose any of **your** No Claim Discount as long as you make no more than two claims in any three year **period of insurance**.

If three claims are made in any three year **period of insurance** **we** will reduce the discount you receive to a one year entitlement in accordance with **our** no claim discount scale applicable at the time **your** policy is due for renewal.

If more than three claims are made in any three year period of insurance **we** will reduce the discount **you** receive to nil.

Regardless of the number of years No Claims Discount to which **you** are entitled **our** agreement to protect **your** No Claim Discount does not mean that the premium cannot be increased at renewal of **your** policy to reflect an adverse claims record or driving history.

General Exceptions

These General Exceptions apply to the whole of the insurance policy.

What is not covered

1. Excluded uses and excluded drivers

We will not cover any liability, loss or damage arising while any vehicle covered by this insurance is being:

- 1.1 used for a purpose which is not permitted or is excluded by the **Certificate of Motor Insurance**; or
- 1.2 used on the Nurburgring Nordschleife or deregulated/derestricted toll roads or any race track, racing circuit or prepared course unless **you** have told **us** about this and **we** have agreed to provide cover; or
- 1.3 driven by, is in the charge of or was last in the charge of anyone not permitted to drive by **your Certificate of Motor Insurance** or temporary cover note or who is excluded by **endorsement**; or
- 1.4 driven by, is in the charge of or was last in the charge of anyone including **you** who is disqualified from driving or has never held a licence to drive a vehicle or is prevented by law from having a licence; or
- 1.5 driven by any person who holds or last held a provisional driving licence unless that person is accompanied by a full licence holder aged 21 years or over and the accompanying full licence holder has held a full driving licence for at least 3 years; or
- 1.6 driven by, is in the charge of or was last in the charge of any person who does not meet the terms or conditions of his/her driving licence; or
- 1.7 used in an unsafe condition or while carrying an insecure load or while carrying a number of passengers that is likely to affect the safe driving of the vehicle; or

1.8 driven by **you** or any person insured to drive, should it be proved to **our** satisfaction that the driver was under the influence of alcohol or drugs at the time of such loss or damage occurring. A conviction under the relevant law (including a conviction for failing to supply a specimen of breath, blood or urine) shall be deemed to be conclusive evidence that the driver at the time of the loss or damage was under the influence of alcohol or drugs. In addition, you or any insured driver must repay all the amounts we have paid arising from the incident including any claimants' damages and costs.

1.9 driven by any person who fails to take medication as prescribed or carry out prescribed treatment or report for a medical examination recommended by a doctor where this inaction contributes to an accident.

General Exception 1 will not apply:

- if the **insured vehicle** has been stolen or taken away without **your** permission; or
- if the **insured vehicle** is in custody of a garage for repair or servicing; or
- under General Exception 1.1 only, while the **insured vehicle** is being used for car sharing purposes as defined in General Condition 9 of this policy.

2. Overseas use

We will not make any payments for any liability loss or damage that occurs outside of the **geographical limits** of this policy unless extended under the terms of Section J - Foreign Use (apart from the minimum cover required by law).

Additionally **we** will not make any payments in respect of any proceedings brought against **you** or judgement passed in any court outside of the **geographical limits**, unless the proceedings or judgement arise out of the **insured vehicle** being used in a foreign country which **we** have agreed to extend this insurance to cover and the proceedings or judgement are brought in such country.

3. Contractual liability

We will not cover any liability you have accepted under an agreement or contract unless **you** would have had that liability anyway.

4. Radioactivity

We will not cover any legal liability of whatsoever nature directly or indirectly caused by or contributed to or arising from:

- ionising radiations or contamination by radioactivity from any irradiated nuclear fuel or from any nuclear waste from the combustion of nuclear fuel; or
- the radioactive toxic explosive or other hazardous properties of any explosive nuclear assembly or nuclear component.

5. War

We will not pay for any loss, damage or liability arising as a consequence of war invasion or act of foreign enemy, hostilities (whether war be declared or not), civil war, rebellion, revolution, insurrection or military or usurped power.

6. Earthquake, riot and civil commotion

We will not pay for death, bodily injury, loss, damage and/or liability arising during (unless **you** prove that it was not occasioned thereby) or in consequence of:

- earthquake; or
- riot or civil commotion occurring elsewhere other than in Great Britain, the Isle of Man or the Channel Islands.

7. Use on airfields

We will not cover any liability in respect of:

- any accident, loss or damage to any aircraft; or
- death or bodily injury arising in connection with any accident loss or damage to any aircraft; or
- any other loss indirectly caused by such accident, loss or damage to any aircraft

incurred, caused or sustained while any vehicle covered by this insurance is in or on any airport or airfield.

8. Pollution

We will not pay for any liability, loss or damage resulting from pollution or contamination however caused, other than as required by the law of any country in which **we** have agreed to provide cover under this policy.

9. Terrorism

We will not cover any liability, loss or damage caused by acts of **terrorism** apart from the minimum level of cover **we** must provide by law.

General Conditions

These General Conditions apply to the whole of the insurance policy.

1. Payment of Premium, Keeping to the Policy Terms & Avoiding Misrepresentation

We will only provide the cover described in this insurance policy if:

- **you** have paid or agreed to pay the premium for the current **period of insurance**, and
- **you** or any person claiming protection has kept to all of the terms and conditions of this policy (including those applied by **Endorsement**) as far as they can apply, and
- in entering into this contract **you** have taken all reasonable care in answering all questions in relation to this insurance honestly and to the best of **your** knowledge.

Your premium is based on information **you** supplied at the start of the insurance, subsequent alteration or renewal. **You** must tell us via your **insurance intermediary** immediately of any change to that information, some examples are any changes to the **insured vehicle** which improve its value, attractiveness to thieves, performance or handling, any change of car, change of occupation (including part-time), change of address (including where car is kept), change of drivers, if **you** or any drivers pass **your** driving test or sustain a motoring or non-motoring conviction or there is a change of main driver.

If **your** premium has been calculated on a limited annual mileage basis **we** will seek evidence at the time of a claim to prove that **your** estimated annual mileage has not been exceeded. If **you** fail to supply appropriate evidence or evidence is provided by **you** which shows that the estimated annual mileage has been exceeded **you** will be required to pay the additional amount of **excess** shown on the endorsement applying to **your** policy.

Under the Consumer Insurance (Disclosure and Representations) Act 2012 **your** failure to take reasonable care to avoid misrepresentation in relation to the information provided could result in **your** policy being cancelled or **your** claim being rejected or not fully paid.

If you or anyone acting on your behalf knowingly commit a fraudulent act or submit a fraudulent document or make a fraudulent statement or exaggerate any claim made under the policy, we will not pay the claim and cover under this and all other insurances currently in force with us with which you are connected will cease immediately. You will not be entitled to any refund of premium under any policy.

2. Looking after your car

You or any permitted drivers are required to maintain the **insured vehicle** in a roadworthy condition. **You** or any person in charge of the **insured vehicle** are required to take all reasonable care to safeguard it and its contents from loss or damage, for example the car should not be left unlocked.

We shall at all times be allowed free access to examine the **insured vehicle**.

3. Having an MOT certificate

There must be a valid Department for Transport test certificate (MOT) in force for the **insured vehicle** if one is needed by law. In the absence of a valid Department for Transport test certificate (MOT) all cover under sections A and B of this insurance is cancelled and of no effect.

4. Accidents or losses

In the event of an accident or incident likely to give rise to a claim which is covered under the policy, **you** must as soon as possible telephone the 24 hour Claims Helpline (this must be within 24 hours of the incident occurring). Please also refer to Page 4 of this policy booklet 'What to do in the Event of an Accident' for further guidance.

If the loss or damage is covered under the policy, the Claims Helpline operator will make arrangements to remove the **insured vehicle** to the nearest **approved repairer**, competent repairer or place of safety, and safeguard the **insured vehicle** and its contents.

We will not pay for further damage to the **insured vehicle** if **you** drive it or attempt to drive it in a damaged condition.

If your claim is due to theft, attempted theft, malicious damage or vandalism, you must also notify the police within 24 hours of discovery of the loss or as near as practical and obtain a crime report number.

If the insured vehicle is stolen and is no longer under your control we will remove it from the Motor Insurance Database (MID) until such time as it is recovered.

Important: If you are advised that your stolen vehicle has been recovered following its theft and it is roadworthy, it is important that you notify your insurance intermediary immediately and before you drive the vehicle, so that we can reinstate it onto the Motor Insurance Database otherwise you run the risk of being stopped by the police as they may suspect the vehicle is not insured.

We have the right to remove the **insured vehicle** at any time to keep claims costs to a minimum. If the **insured vehicle** is damaged beyond economical repair we will arrange for it to be stored safely at premises of **our** choosing.

If **we** ask to examine driving licences and vehicle documentation before agreeing to settle a claim under this policy **you** must supply this documentation before **we** can proceed with the settlement.

Any indication of a claim against **you** must be notified to **us** as soon as possible. Any writ, or notification of civil or criminal proceedings should be sent to **us** by recorded delivery immediately.

We shall be entitled to take over and conduct the defence or settlement of any claim or prosecute any claim in the name of any person covered by this insurance.

5. Claims procedures

No admission of liability, payment or promise of payment shall be made or given by **you** or any person on **your** behalf. No proceedings may be commenced against, or settlement accepted from, any other party without **our** written consent.

We shall have discretion in the conduct of any proceedings or in the settlement of any claim.

You must give us whatever co-operation, information and assistance **we** require in dealing with any claim under this policy.

If there is any other insurance in force which covers the same loss, damage or liability as this insurance, **we** will only pay **our** proportionate share of the claim.

6. Cancellation

Cancelling the policy within the reflection period

This insurance provides **you** with a reflection period to decide whether **you** wish to continue with the full policy. The reflection period is for 14 days from the date you receive **your** policy documentation.

If a period of less than 14 days has elapsed since **you** received **your** policy documentation, and **you** have not made a total loss claim, you have the right to cancel the policy and receive a refund of premium.

- If at the date of cancellation **your** policy has not yet commenced **you** will receive a full refund from **us**; or
- If **your** policy has already commenced, **we** will refund the premium relating to the remaining **period of insurance** calculated on a proportionate basis dependent on the number of days left to run under the policy less a charge of £25 plus Insurance Premium Tax if applicable to cover **our** administration costs.

cancelling the policy after the reflection period

Cancellation by you

You or **your Insurance Intermediary** can cancel this policy either from the date **we** are notified, in writing, or a later date as requested by **you**. Providing there have been no claims in the current **period of insurance we** will refund the premium relating to the remaining **period of insurance** calculated on a proportionate basis dependent on the number of days left to run under the policy less an administration fee of no more than £50 plus Insurance Premium Tax if applicable to take into account **our** costs in providing **your** policy.

Cancellation by Us

We can cancel this policy at any time if there are serious grounds to do so, including but not limited to the following examples:

- where **your insurance intermediary** has been unable to collect a premium payment (payment terms including the procedures in the event of non-payment of the premium will have been agreed between **you** and **your insurance intermediary** when **you** took out this policy); or
- **you** have failed to take reasonable care in providing information in relation to this insurance as required by General Condition 1 of this policy; or
- **you** have failed to supply requested validation documentation (evidence of No Claim Discount, copy driving licence, etc.); or
- **you** have failed to co-operate or provide information and assistance in relation to any claim under this policy or with regards to the administration or operation of this policy; or
- where **you** fail to maintain the **insured vehicle** in a roadworthy condition or **you** fail to look after it in accordance with General Conditions 2 and 3 of this policy; or
- where **we** have grounds to suspect fraud or misrepresentation; or

- where **you** use threatening or abusive behaviour towards a member of **our** staff or a member of staff of **your insurance intermediary** or **our** supplier.

We will do this by giving **you** 7 days' notice in writing to **your** last address notified to **us**. **Your** last notified address may include an email address nominated by **you** to accept correspondence.

We will refund the premium relating to the remaining **period of insurance** calculated on a proportionate basis dependent on the number of days left to run under the policy less an administration fee of no more than £50 plus Insurance Premium Tax if applicable to take into account **our** costs in providing **your** policy. The pro rata refund of premium (less the administration fee) is only available as long as:

- the **insured vehicle** has not been the subject of a total loss claim (i.e. written-off or stolen and not recovered); and/or
- cancellation is not due to any fraudulent act by **you** or anyone acting on **your** behalf.

We also reserve the right to retain all premium paid for the current **period of insurance** in the event that a fault claim has been made against the policy during this period.

Non-payment of premium

In the event that there has been a loss or incident likely to give rise to a claim during the current **period of insurance** and premium amounts are outstanding **we** may at **our** discretion reduce any claims payment by the amount of outstanding or overdue premiums that **you** owe **us**.

Guidance Notes - Policy Cancellation

Please note that any refund from us whether during or after the reflection period may be subject to a further charge levied by your insurance intermediary. Any charges levied by your insurance intermediary will be in accordance with the terms and conditions agreed between you and them at the time you arranged this insurance.

7. Total losses and stolen vehicles

If as a result of a claim the **insured vehicle** is determined to be a total loss or **your** vehicle has been stolen and not recovered, this policy will be cancelled without refund of premium unless **you** change **your** vehicle to another that would normally be acceptable to **us** or the stolen vehicle is recovered and is not a total loss.

In the event of the policy being cancelled due to the **insured vehicle** being a total loss or stolen and not recovered, and there being no replacement vehicle to insure (or if there is a replacement vehicle to insure which is unacceptable to us), all outstanding or overdue premiums, including any administration charge due, must be paid immediately. **We** may at **our** discretion reduce the claims payment by the amount of outstanding or overdue premiums that **you** owe **us**.

8. Right of recovery

If under the laws of any country in which this insurance applies, **we** have to make payments which but for those laws would not be covered by this policy, **you** must repay the amounts to us.

You or the person who caused the accident must also repay **us** any money **we** have to pay because of any agreement **we** have with the Motor Insurers' Bureau.

Any payment **we** have to make because **we** are required to do so by compulsory insurance law or an agreement with the Motor Insurers' Bureau will prejudice **your** No Claim Discount and will also mean that there will be no entitlement to a return of premium if the policy is cancelled or declared void.

9. Car sharing

This policy allows **you** to carry passengers for social or similar purposes and **your** receipt of a mileage allowance or a payment by a passenger towards the cost of fuel will not invalidate cover as long as:

- **you** do not make a profit from the car sharing arrangement; and
- **your** insured vehicle is not adapted to carry more than eight people (including the driver); and
- **you** are not carrying passengers as customers of a passenger-carrying business.

10. Fraudulent claims

If:

- i) **You** make a claim that is false, fraudulent or deliberately exaggerated; or
- ii) **You** have made a false declaration or statement in support of any such claim;

We can at our sole discretion:

- 1) Deny the claim in its entirety and will not pay any legitimate part of Your claim;
- 2) Recover any payment already made under the claim;
- 3) Cancel the policy with effect from the date you made the false claim or representations without returning your premium.

11. Tax and registration

Your insured vehicle must be taxed where applicable and registered within the **territorial limits**.

Our Service Commitment

What to do if you have a complaint

We are dedicated to delivering a first class level of service to all of **our** policyholders. However, **we** accept that things can occasionally go wrong and would encourage you to tell us about any concerns **you** have so that **we** can take steps to make sure the service **you** receive meets **your** expectations in the future.

If a dispute regarding your policy or claim arises and cannot be resolved by reference to your insurance intermediary the following explains the procedures for resolving your complaint:

The resolution of complaints in relation to **your** policy (or any claim made under it) is delegated to **our** service providers in the United Kingdom, Zenith Insurance Management UK Limited.

If **you** have a complaint, please contact **our** service providers at the address below:

Zenith Customer Relations
Zenith Insurance Management UK Limited
PO Box 730
Chesterfield
S40 9LL
Tel: 0344 705 0630
Email: complaints@zenith-insurance.co.uk

When contacting Zenith Insurance Management UK Limited please provide:

- A policy number and/or claim number.
- An outline of **your** complaint.
- A contact telephone number.

Our service providers will make every effort to resolve **your** complaint by the end of the third working day after receipt. If they cannot resolve **your** complaint within this timeframe they will acknowledge **your** complaint within five working days of receipt and do their best to resolve the problem within four weeks by sending **you** a final response letter. If they are unable to do so, they will write to advise **you** of progress and will endeavour to resolve **your** complaint in full within the following four weeks.

If they are still unable to provide **you** with a final response at this stage, they will write to **you** explaining why and advise when **you** can expect a final response. At this point **you** may refer **your** complaint to The Financial Ombudsman Service at the following address:

The Financial Ombudsman Service
Exchange Tower
Harbour Exchange Square
London
E14 9SR
Email: complaint.info@financial-ombudsman.org.uk

What you should know

You may go directly to the Financial Ombudsman Service when **you** first make **your** complaint, but the Ombudsman will only review **your** complaint at this stage with **our** consent. However, **we** are still required to follow the procedure stated above.

If **you** have received a final response but are dissatisfied, **you** have the right of referral to the Financial Ombudsman Service within six months of the date of your final response letter. **You** may only refer to the Ombudsman beyond this time limit if **we** have provided **our** consent.

Whilst **we** and **our** UK service providers are bound by the decision of the Financial Ombudsman Service, **you** are not. Following the complaints procedure above does not affect **your** right to take legal action.

Customer feedback

If **you** have any suggestions or comments about **our** cover or the service **we** have provided please write to **our** UK service providers:

Operational Standards
Zenith Insurance Management UK Limited
Chester House
Harlands Road
Haywards Heath
West Sussex
RH16 1LR

We always welcome feedback to enable us to improve our products and services.

Telephone Recording

For our joint protection telephone calls may be recorded and monitored by us.

Financial Services Compensation Scheme

Zenith Insurance Plc is a member of the Financial Services Compensation Scheme (FSCS). You may be entitled to compensation from this scheme if we cannot meet our liabilities under this policy.

Further information about the scheme is available on the FSCS website at www.fscs.org.uk or by writing to:

FSCS
10th Floor
Beaufort House
15 St Botolph Street
London
EC3A 7QU

Your insurance intermediary

In the event that we are unable to continue to trade with your insurance intermediary because they have ceased to trade through bankruptcy or liquidation or in the event that their relevant FCA authorisation is revoked we reserve the right to pass your policy and all details on to another intermediary. If you do not wish this to happen then please put your request in writing to us.

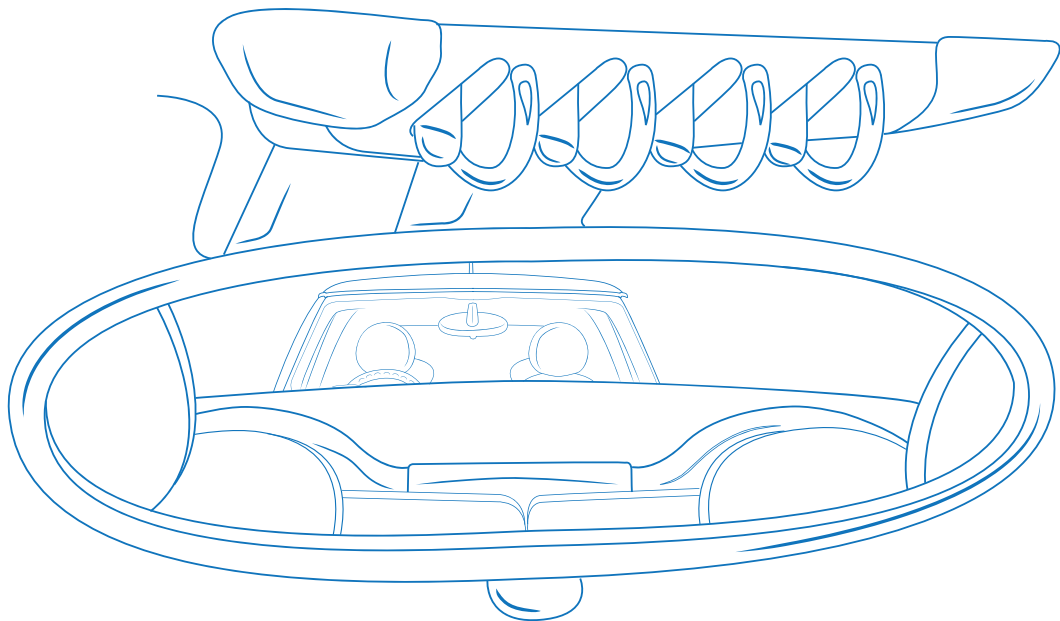

How we use your information

Introduction

We believe in keeping your information safe and secure. This section explains:

- What we do with your information
- How we may check the information you have provided to us against other sources such as databases
- Who we share your information with, and
- How we may use your information.

We take steps to make sure we keep your information safe and secure. We are governed by the Data Protection legislation applicable in both the United Kingdom and Gibraltar. In this section we tell you about the systems we have in place that allow us to detect and prevent fraudulent applications and claims.

How we may collect your information

We may collect details about you from

- Information you give to brokers
- Information you give us in online forms and other forms
- Other sources such as Google Earth and social media
- Third parties and other sources
- Telematics systems.

What information we may collect about you

We collect details including details about your health, personal circumstances, claims history, credit history, motoring history and other relevant details. We may collect information on you from databases such as the electoral roll and county court judgment records.

How we may share your information

In order to provide our services to you, we may share your information with other insurance companies, solicitors, regulators, business partners and suppliers. We may also have a legal obligation to provide your information, in certain circumstances, with regulators, police and other public bodies.

Information you supply may be used for the purposes of insurance administration by us and third parties. These third parties may share your information with their own agents.

How we may use your information

We may use your information for a number of purposes. These include:

- Providing you with our services
- Dealing with your claim
- Carrying out checks such as fraud checks and credit checks
- Providing you with information about our products and services.

We give details about some of these processes below.

Driving Licence checks

We may also provide your (or any named third party) driving licence number (DLN) and other details to the DVLA to confirm licence status, entitlement and relevant restriction information and endorsement/conviction data.

Searches may be carried out prior to your policy commencing and at any point during your insurance policy including any mid-term adjustment and renewal stage. For details relating to information held about you by the DVLA please visit www.dvla.gov.uk.

The DVLA may also be used to search your (or any named third party's) no claims discount (NCD) details against a no claims discount database to obtain information in relation to your NCD entitlement.

We may pass details of your no claims discount to certain organisations to be recorded on a NCD database.

Providing you with details on our Products and Services

We would like to send you information about products and services of ours and other companies in our Group which may be of interest to you.

We may contact you by telephone, letter or email. If you have consented to receive marketing you may opt out at a later date. You have a right at any time to stop us from contacting you for marketing purposes or giving your information to other members of the Group.

If you no longer wish to be contacted for marketing purposes then please contact us at

Business Assurance Team
Zenith Insurance Plc
 45 Westerham Road
 Bessels Green
 Sevenoaks
 Kent
 TN13 2QB

Motor Insurance Database

Your policy details will be added to the Motor Insurance Database (MID), run by the Motor Insurers' Bureau (MIB). MID and the data stored on it, including your personal details, may be looked at and used by certain statutory and/or authorised bodies including the Police, the DVLA, the Insurance Fraud Bureau and other bodies permitted by law.

If you are involved in an accident (in the UK or abroad), insurers and/or the MIB may search the MID to obtain relevant information.

Persons pursuing a claim in respect of a road traffic accident (including citizens of other countries) may also obtain relevant information which is held on the MID.

It is vital that the MID holds your correct registration number. If it is incorrectly shown on the MID you are at risk of having your vehicle seized by the Police. You can check that your correct registration details are shown on the MID at www.askmid.com

Fraud Prevention and Detection

We carry out fraud checks on our customers. We do this in order to prevent fraud and also to help us make decisions about the provision, pricing and administration of insurance.

When carrying out these checks, we will search against fraud detection databases.

We may pass details about you to some of these databases.

Law enforcement agencies, financial service providers, fraud prevention agencies, police and other organisations may also access these databases.

Claims History

We may process data relating to your claims history for the purposes of assessing any claim you may make.

The aim is to help us to check information provided and also to prevent fraudulent claims. When you tell us about an incident we will pass information relating to it to these databases. We may search these databases when you apply for insurance, in the event of any incident or claim, or at time of renewal.

Credit Searches and Accounting

In assessing an application for insurance or policy renewal, we may search files made available to us by credit reference agencies. They keep a record of that search.

Credit reference agencies share information with other organisations, enabling applications for financial products to be assessed or to assist the tracing of debtors, or to prevent fraud.

How we use your information (continued)

Transfers

Sometimes your information may be transferred outside the European Economic Area by us, by the organisations with whom we share your information or by the servants and agents of these organisations. If we do this we will seek to ensure that anyone to whom we pass it provides an adequate level of protection.

Obtaining a copy of your data

On payment of a £10 fee you are entitled to receive a copy of the information we hold about you. If you have any questions, or you'd like to find out more about this notice please write to

Business Assurance Team
Zenith Insurance Plc
45 Westerham Road
Bessels Green
Sevenoaks
Kent
TN13 2QB

Numbers to Call

Had an accident?

We're here to get you back on the road.

The procedure outlined below must be followed for all accidents, regardless of who was responsible. Even if you do not intend to make a claim for the damage to your vehicle you must still report the accident.

Delay in notification may invalidate your right to claim.

At the roadside? Call 03330 436 513

To obtain immediate assistance at the roadside call the Roadside Priority Claims Helpline on **03330 436 513**.

Experienced advisors will take initial claim details and discuss recovery of your vehicle.

Unable to call from the roadside? Call 03330 436 519

If you are unable to call from the roadside you must call the 24 hour Claims Helpline on **03330 436 519** as soon as it is safe to do so.

Please call within 24 hours of the accident, but ideally within 1 hour.

Calling straightaway **provides you with benefits which may include the following** (dependent on the level of policy cover you have):

- **FREE courtesy car** while your car is being repaired (subject to availability).
- Windscreen repair/replacement.
- **FREE** collection and re-delivery.
- **FREE** car cleaning service.
- Repairers' work guaranteed for three years.

Does the accident involve a third party?

- Pass your details along with your policy number to the third party.
- If you are calling from the roadside an advisor may ask to speak to the third party, or ask you to request them to make contact on **03330 436 558** within 1 hour.
- The third party may be entitled to a number of services free of charge (dependent on fault).

Private Car Insurance Policy

www.zenith.gi

All correspondence should be addressed to:

Zenith Insurance Management UK Limited, Chester House, Harlands Road, Haywards Heath, West Sussex RH16 1LR
Zenith Insurance Management UK Limited is an appointed service provider to but is not an agent of Zenith Insurance plc.
Zenith Insurance Management UK Limited is registered in England & Wales No. 5309111 and authorised and regulated
by the Financial Conduct Authority (No 429279). Zenith Insurance Plc, 846-848, Europort, Gibraltar.

Zenith Insurance Plc is regulated by the Gibraltar Financial Services Commission and subject to a limited regulation by the Financial Conduct Authority and the Prudential Regulation Authority in respect of underwriting insurance business in the UK (No. 211787).